

COMPACT EXCAVATOR
R25Z-9AK

Operating weight: 2580 kg (Cabin) / 2430 kg (Canopy)
Engine Power: 18.5 kW (24.9 HP) / 2400 rpm
Bucket capacity: 0.07 m³



Walk-around

R25Z-9AK

Productivity & Efficiency

- Advanced hydraulic system
- Swing boom function
- Various piping options
- Excellent break out forces
- Compact design: Zero tail swing



Operator comfort

- Spacious cabin
- Ergonomic soft grip joysticks
- Centralised monitoring system with warning indicators
- Mechanical suspension seat with seat belt
- Armrests
- Radio & MP3-player

Serviceability & Durability

- Wide opening hood & covers
- Easy-to-serve air cleaner
- Centralised grease fittings
- Long-life hydraulic oil and filters
- Durable shims & bushings
- Extended lifetime components

Safety

- Robust, stress-resistant upper frame
- X-type centre frame
- Excellent visibility
- Boom/dozer cylinder cover

Productivity & Efficiency

EFFICIENT PERFORMANCE IN LIMITED-SPACE ENVIRONMENTS

Developed for maximum productivity, the R25Z-9AK has a compact design and zero tail swing radius to allow efficient operation in confined spaces. Its robust, eco-friendly Kubota engine is powerful, reliable and fuel-efficient, while the hydraulic system enables fast operation combined with high controllability. The result is a versatile and dependable workhorse that helps you to optimise performance and economy every day, on a broad range of jobs.



Tier 4 Final (2014)
EU Stage V (2019)

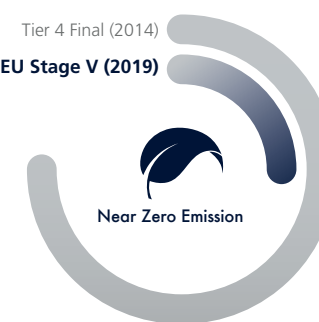

Engine

The compact Kubota D1305 EU Stage V compliant engine is powerful, fuel-efficient and keeps emissions to a minimum without requiring additional aftertreatment systems. The engine combines high performance with low noise and vibration.



Upper and lower frame

The upper frame structure is designed to absorb high external stress. An X-type centre frame and reinforced box section track frame provide exceptional strength and durability.



Hydraulic oil and filter

All components are selected for extended service intervals, low operating costs and minimal machine downtime. This includes bushings with prolonged lube intervals (250 hrs), wear-resistant, noise-reducing polymer shims and long-life hydraulic filters (1000 hrs) and hydraulic oil (5000 hrs). Efficient cooling systems and integrated preheating systems further enhance performance and durability.

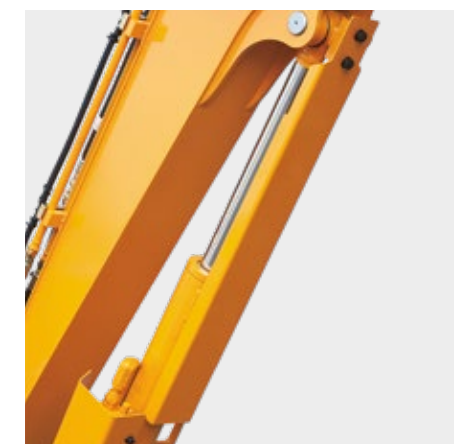

Cylinder covers

The standard boom cylinder cover and dozer cylinder cover provide additional protection.



Trailer transport

There's no need for a truck to transport the R25Z-9AK between jobs. It can be moved on a small trailer, with an ordinary car driver's licence.



Cabin structure

The robust cabin structure is built using integrally welded slow-stress, high-strength steel to form a tough, durable upper and lower frame. Structural integrity has been tested using FEM (Finite Elements Method) analysis and long-term durability tests.



Selector valve

The selector valve makes it easy to select single acting piping (for a breaker) or double acting piping (for a clamshell). It is placed on the front side of the fuel tank for quick access and control.

Operator comfort

COMFORT AND CONVENIENCE DESIGNED AROUND YOU

The R25Z-9AK cabin was designed to offer every operator a productive and stress-free working environment. Its ergonomic design will help you perform easier and with lower fatigue. Control levers are easily accessible and an instrument display is provided to keep the operator informed of relevant machine information.



Control levers

The left- and right-hand control levers are located for maximum convenience. The joysticks have enough space for additional option switches. An optional pattern change valve enables easy adaptation of the joystick control pattern.



“There’s plenty of space and everything I need is right where I need it!”



Storage

The right-hand console features different-sized cupholders for storing large and small drinks. A lockable storage box is installed under the seat to hold your belongings.



Tilting left-side console

The left-side console can be tilted, making it easier to enter and exit the cabin.



Pedals

The travel, boom offset and attachment pedals are configured for maximum comfort. The pedals can be folded in to create extra foot space.

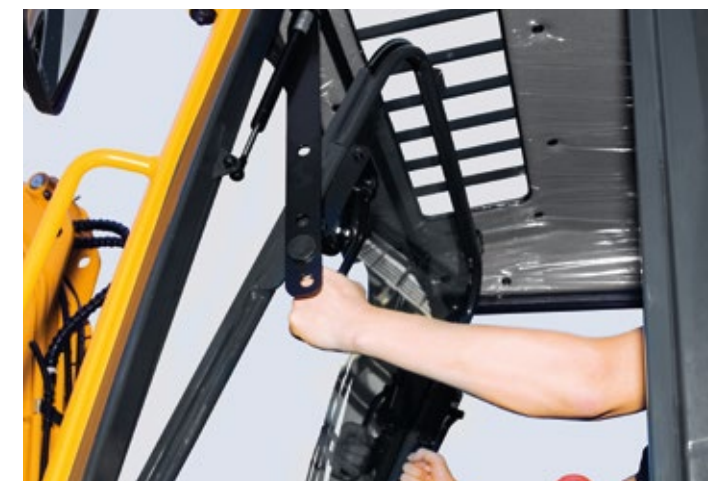

Slidable front window

The slidable front window (cabin model only) is easy to open and is held safely in the open position.

Safety

PROTECTION FOR YOU AND YOUR EQUIPMENT

The R25Z-9AK features a range of innovations to offer extra protection for you and your surroundings. The zero tail swing ensures that you can work safely and confidently in confined spaces, close to walls, on roadways or in urban areas. All-round visibility is maximised, whether you choose the cabin model with its large windows and narrow pillars, or an open canopy.

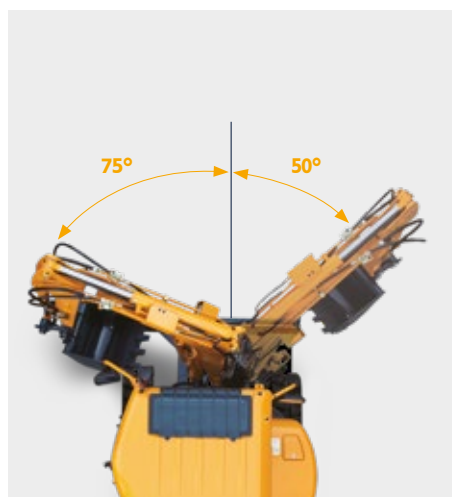

Cabin

The operator is protected by a robust cabin structure, built using strong, slim tubing to optimise both sturdiness and visibility. The canopy and cabin frame comply with international TOPS, ROPS and FOG standards.

Safety lever

A safety lever is installed to prevent unintentional activation of the hydraulic attachments. When the safety lever is positioned upright, hydraulic functions are disabled.

Boom swing

The boom swing function is designed for safe, efficient work in congested residential and urban areas. The boom can be offset to the left or right within an operating range.

Serviceability & Durability

EASY SERVICING FOR TROUBLE-FREE OWNERSHIP

Working to a busy schedule, you need equipment that runs smoothly and can be easily maintained. The R25Z-9AK is designed for fast, easy servicing and monitoring with convenient access to important servicing points.

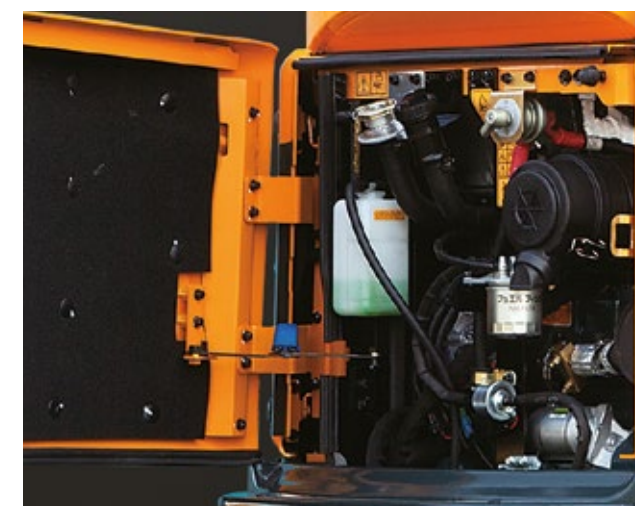

Air cleaner

The durable air cleaner is designed for convenient maintenance.

Engine hood/cover

Wide opening doors, covers and hoods provide easy access for servicing tasks.



Indicators and gauges

An array of gauges and warning indicators are displayed on the monitor. The monitoring system allows you to check machine status at a glance and includes an hour meter, oil pressure lamp, battery change lamp, engine coolant temperature gauge and fuel gauge.

Centralised grease fittings

The lubrication bank centralises grease fittings for quick, easy servicing.



Genuine parts and warranties

THE BEST WAY TO PROTECT YOUR INVESTMENT

Hyundai Genuine Parts, accessories and warranty programmes are specially designed to keep your machine covered. They increase uptime and maintain the performance, comfort, and convenience that are built into your equipment.

Fuel filters

Hyundai fuel filters provide the right degree of filtration to keep your engine clean. They are designed to meet and exceed the engine manufacturer's prerequisites for water separation and dirt filtration, prolonging the life of your engine.

Undercarriage parts

Hyundai track components deliver exceptional ride performance. The materials used comply with stringent quality control measures to ensure the highest reliability.

Hyundai Genuine parts

Hyundai Genuine parts have the same design as those installed when your machine left the factory. They are subjected to rigorous quality inspections and tests to make sure they meet Hyundai's strict requirements for quality and durability. As well as minimising downtime, this helps to ensure peak performance on every task.



Hyundai warranties

Our warranties are designed to give you the cover you need to build your business with confidence and peace of mind.

Standard warranties

We offer standard warranty coverage for all compact excavators. In addition to this standard coverage, optional and extended warranty periods are available, so you can benefit from full warranty coverage for longer, and even over the full lifetime of your machines. Please discuss the optimal solution for your needs with your local Hyundai dealer.

Extended warranties

Our extended warranties help you maintain full control over your operating costs. If you combine an extended warranty programme with a tailored maintenance contract, you can completely avoid unexpected costs.



A network you can rely on

Hyundai Construction Equipment Europe prioritises quick, reliable intervention to keep your equipment running reliably. In the 13000 m² warehouse, Hyundai covers over 96% of all Genuine Parts. With one of Europe's most advanced automated warehousing systems, we are able to maintain availability and efficient delivery of all our Genuine Parts. Moreover, we guarantee a 24-hour delivery service across our European dealer network.

SPECIFICATIONS

ENGINE			
Maker / Model		Kubota / D1305-EF04	
Type		4 Cycle Diesel engine, in line, water cooled	
Rated flywheel horse power	SAE	J1995 (gross)	18.5 kW (24.9 HP) / 2400 rpm
		J1349 (net)	18.2 kW (24.4 HP) / 2400 rpm
	DIN	6271/1 (gross)	18.5 kW (25.2 PS) / 2400 rpm
		6271/1 (net)	18.2 kW (23.5 PS) / 2400 rpm
Max. torque		8.3 kgf.m / 1600 rpm	
Bore x stroke		78 mm x 88 mm	
Piston displacement		1261 cc	
Batteries		12 V - 80 Ah	
Starting motor		12 V - 1.4 kW	
Alternator		12 V - 40 A	

HYDRAULIC CONTROLS	
Pilot control	Two joysticks with one safety lever (LH): Swing and arm, (RH): Boom and bucket with horn (ISO)
Engine throttle	Mechanical, cable type

SWING SYSTEM	
Swing motor	Axial piston motor
Swing reduction	Planetary gear reduction
Swing bearing lubrication	Grease-bathed
Swing brake	Wet disc
Swing speed	9.1 rpm

HYDRAULIC SYSTEM	
MAIN PUMP	
Type	Variable displacement piston pumps
Max. flow	2 x 27.6 + 19.6 l/min
Sub-pump for pilot circuit	Gear pump

DRIVES & BRAKES	
Max. travel speed (high) / (low)	4.3 km/h / 2.4 km/h
Maximum traction force	2.4 ton
Maximum gradeability	30°
Parking brake	Wet disc

HYDRAULIC MOTORS	
Travel	Two speed axial piston motor with counter balance valve and parking brake
Swing	Axial piston motor with automatic brake

DIGGING FORCE (ISO)	
Bucket	2150 kgf
	21.1 kN
	4740 lbf
Arm [Long Arm]	1490 [1310] kgf
	14.6 [12.8] kN
	3280 [2890] lbf

RELIEF VALVE SETTING	
Implement circuits	220 Kgf/cm ² (3130 psi)
Travel	220 Kgf/cm ² (3130 psi)
Swing circuits	175 Kgf/cm ² (2489 psi)
Pilot circuit	30 Kgf/cm ² (430 psi)
Service valve	Installed

OPERATING WEIGHT (APPROXIMATE)		
Operating weight, including 1945 mm boom, 1120 m arm, SAE heaped 0.07 m ³ excavator bucket, lubricant, coolant, full fuel tank, full hydraulic tank and all standard equipments.		
OPERATING WEIGHT		
Shoe Width		Rubber shoe 250 mm
Operating Weight	Cabin	2580 kg
	Canopy	2430 kg
Ground Pressure	Cabin	0.32 kg/cm ²
	Canopy	0.30 kg/cm ²

HYDRAULIC CYLINDERS	
No. of cylinder bore x stroke	Boom: 75 x 565 mm
	Arm: 70 x 500 mm
	Bucket: 55 x 420 mm
	Boom swing: 75 x 400 mm
	Dozer blade: 85 x 140 mm

OPERATOR'S CAB	
Noise Levels (dynamic value)	Exterior Sound Power Level (ISO 6395:2008): 94 dB (A)
	Operator Sound Pressure Level (ISO 6396:2008): 75 dB(A)

UNDERCARRIAGE	
X-leg type center frame is integrally welded with reinforced box-section track frames. The undercarriage includes lubricated rollers, track adjusters with shock absorbing springs and sprockets and rubber shoes.	
Center frame	X-leg type
Track frame	Pentagonal box type
No. of carrier rollers on each side	1
No. of track rollers on each side	3

COOLANT & LUBRICANT CAPACITY	
	liter
Fuel tank	30
Engine coolant	5.0
Engine oil	5.9
Hydraulic tank	27

TRAVEL LEVERS	
Traveling and steering : Two levers with foldable pedals.	

DIMENSIONS & WORKING RANGE

DIMENSIONS R25Z-9AK

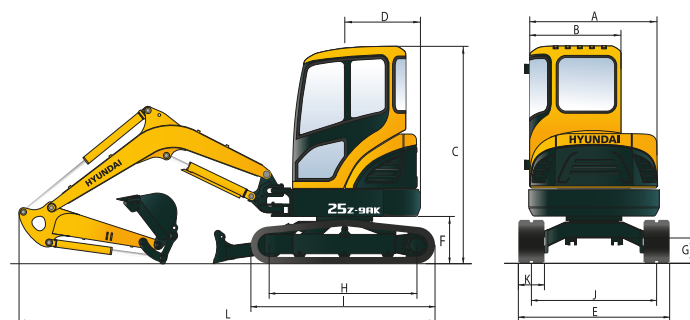

Unit : mm

A	Overall width of upper structure	1485
B	Overall width of cab	1050
C	Overall height of cab	2500
D	Tail swing radius - standard counterweight	775
D'	Tail swing radius - additional counterweight	875
E	Overall width	1500
F	Clearance under counterweight	510
G	Ground clearance	290
H	Tumbler distance	1490
I	Track length	1910

J	Track gauge	1250
K	Track shoe width	250
L	Overall length - Standard Arm	4030
	Overall length - Long Arm	4100

WORKING RANGE R25Z-9AK

Unit : mm

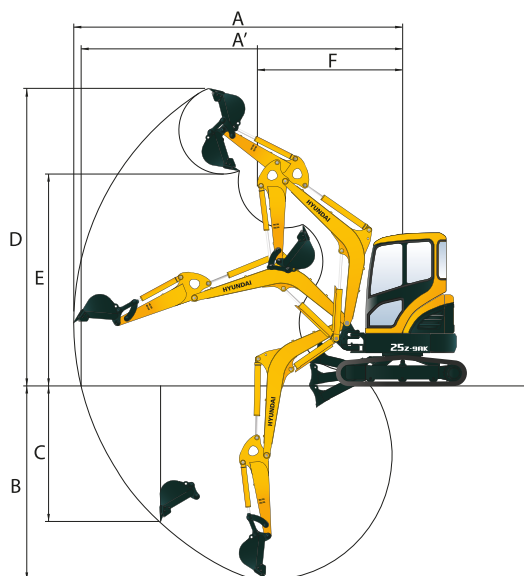

	Boom length	1945
	Arm length	1120 *1350
A	Max. digging reach	4480 *4680
A'	Max. digging reach on ground	4340 *4540
B	Max. digging depth	2420 *2645
C	Max. vertical wall digging depth	1480 *1605
D	Max. digging height	4150 *4235
E	Max. dumping height	2930 *3030
F	Min. front swing radius	1980 *1970

* Long arm

LIFTING CAPACITY

Rating over-front Rating over-side or 360 degrees

R25Z-9AK MONO BOOM

Boom: 1945 mm, Arm: 1120 mm, counterweight: 117 kg, Shoe: 250 mm, dozer down



Lift-point height m	kg	Lift-point radius										At max. Reach					
		1.0 m		1.5 m		2.0 m		2.5 m		3.0 m		3.5 m		Capacity	Reach		
														kg	m		
3.0 m	kg														*720	460	2.88
2.5 m	kg									*670	440				*720	370	3.32
2.0 m	kg									*710	430	*720	340	*710	320	3.61	
1.5 m	kg					*1150	810	*910	560	*800	420	*750	330	*710	290	3.78	
1.0 m	kg							*1160	540	*920	410	*810	320	*730	280	3.86	
0.5 m	kg							*1360	520	*1040	400	*860	320	*780	280	3.85	
0.0 m	kg					*1430	710	*1470	510	*1110	390	*890	310	*810	280	3.75	
-0.5 m	kg	*1010	*1010	*1190	1190	*2080	710	*1470	500	*1110	390	*870	310	*840	300	3.56	
-1.0 m	kg	*1570	*1570	*1920	1190	*1880	710	*1360	500	*1020	390			*860	350	3.25	
-1.5 m	kg	*2290	*2290	*2280	1210	*1510	720	*1090	510					*880	440	2.77	
-2.0 m	kg																

Boom: 1945 mm, Arm: 1120 mm, counterweight: 117 kg, Shoe: 250 mm, dozer up

Lift-point height m	kg	Lift-point radius										At max. Reach					
		1.0 m		1.5 m		2.0 m		2.5 m		3.0 m		3.5 m		Capacity	Reach		
														kg	m		
3.0 m	kg														520	430	2.88
2.5 m	kg									490	410				410	340	3.32
2.0 m	kg									480	410	370	310	350	300	3.61	
1.5 m	kg					920	750	630	530	470	390	370	310	320	270	3.78	
1.0 m	kg							610	500	460	380	360	300	310	260	3.86	
0.5 m	kg								580	480	440	370	350	300	310	260	3.85
0.0 m	kg					820	660	570	470	440	360	350	290	310	260	3.75	
-0.5 m	kg	*1010	*1010	*1190	1080	810	650	570	470	440	360	350	290	340	280	3.56	
-1.0 m	kg	*1570	*1570	1420	1090	820	660	570	470	430	360			390	320	3.25	
-1.5 m	kg	*2290	*2290	1440	1110	830	670	580	480					500	410	2.77	
-2.0 m	kg																

















- Lifting capacity are based on ISO 10567.
- Lifting capacity of the Robex Series does not exceed 75% of tipping load with the machine on firm, level ground or 87% of full hydraulic capacity.
- The Lift-point is bucket pivot mounting pin on the arm (without bucket mass).
- (*) indicates load limited by hydraulic capacity.
- Caution: please be aware of the local regulations and instructions for lifting operations.

LIFTING CAPACITY

















 Rating over-front  Rating over-side or 360 degrees

R25Z-9AK MONO BOOM

Boom: 1945 mm, Arm: 1350 mm, counterweight: 247 kg, Shoe: 250 mm, dozer down

Lift-point height m		Lift-point radius												At max. Reach					
		1.0 m		1.5 m		2.0 m		2.5 m		3.0 m		3.5 m		4.0 m		Capacity	Reach		
																		m	
3.0 m	kg									*600	500						*640	460	3.17
2.5 m	kg									*570	510	*640	390				*590	380	3.56
2.0 m	kg									*620	500	*640	390				*580	340	3.82
1.5 m	kg									*770	650	*720	490	*680	380		*580	310	3.98
1.0 m	kg					*1470	880	*1030	620	*850	470	*750	380	*700	310		*600	300	4.05
0.5 m	kg					*1720	840	*1270	600	*980	460	*820	370	*730	300		*640	300	4.05
0.0 m	kg					*1580	810	*1420	580	*1070	450	*880	360				*700	300	3.96
-0.5 m	kg	*900	*900	*1120	*1120	*1970	810	*1470	580	*1110	440	*890	360				*780	320	3.78
-1.0 m	kg	*1330	*1330	*1660	1350	*2000	810	*1420	570	*1070	440						*820	360	3.50
-1.5 m	kg	*1860	*1860	*2410	1360	*1720	820	*1230	580	*900	450						*850	430	3.07
-2.0 m	kg			*1780	1390	*1170	840										*860	650	2.37

Boom: 1945 mm, Arm: 1350 mm, counterweight: 247 kg, Shoe: 250 mm, dozer up

Lift-point height m		Lift-point radius												At max. Reach					
		1.0 m		1.5 m		2.0 m		2.5 m		3.0 m		3.5 m		4.0 m		Capacity	Reach		
																		m	
3.0 m	kg									560	470						510	430	3.17
2.5 m	kg									560	480	430	370				420	360	3.56
2.0 m	kg									550	470	430	370				370	320	3.82
1.5 m	kg									730	610	540	460	420	360		340	290	3.98
1.0 m	kg					1000	820	700	590	530	440	420	350	340	290		330	280	4.05
0.5 m	kg					960	780	670	560	510	430	410	340	330	280		330	280	4.05
0.0 m	kg					930	760	660	540	500	420	400	340				340	280	3.96
-0.5 m	kg	*900	*900	*1120	*1120	930	750	650	540	490	410	400	330				360	300	3.78
-1.0 m	kg	*1330	*1330	1600	1240	930	750	650	540	490	410						400	340	3.50
-1.5 m	kg	*1860	*1860	1620	1250	940	760	650	540	500	420						480	410	3.07
-2.0 m	kg			1650	1280	960	780										730	600	2.37

- Lifting capacity are based on ISO 10567.
- Lifting capacity of the Robex Series does not exceed 75% of tipping load with the machine on firm, level ground or 87% of full hydraulic capacity.
- The Lift-point is bucket pivot mounting pin on the arm (without bucket mass).
- (*) indicates load limited by hydraulic capacity.
- Caution: please be aware of the local regulations and instructions for lifting operations.

STANDARD/OPTIONAL EQUIPMENT

STANDARD EQUIPMENT

CERTIFIED CABIN
FOG (Falling Object Guard)
TOPS (Tip-Over Protective Structure)
ALL-WEATHER STEEL CAB WITH ALL-AROUND VISIBILITY
SAFETY GLASS WINDOWS
SLIDING FOLD-IN FRONT WINDOW
SLIDING SIDE WINDOW
LOCKABLE DOOR
ACCESSORY BOX
CENTRALISED MONITORING
GAUGES
Fuel level gauge
Engine coolant temperature gauge
WARNING LAMPS
Engine oil pressure
Engine coolant temperature
Preheat engine
Low battery
Air cleaner clogging
Fuel empty
DOOR AND LOCKS, ONE KEY FITS ALL
MECHANICAL SUSPENSION SEAT WITH SEAT BELT
CONSOLE BOX TILTING SYSTEM (LH.)
ACCUMULATOR, WORK EQUIPMENT LOWERING
TRAVEL ALARM
WORKING LIGHT BOOM
ELECTRIC HORN
BATTERY (1 X 12 V X 80 AH)
BATTERY MASTER SWITCH
AUTOMATIC SWING BRAKE
SAFETY VALVE FOR BOOM AND ARM CYLINDERS AND OVERLOAD WARNING DEVICE
SAFETY VALVE FOR DOZER BLADE CYLINDER
REMOVABLE RESERVOIR TANK
WATER SEPARATOR, FUEL LINE
MONO BOOM (1.945 M)
ARM (1.12 M)
RUBBER TRACK (250 MM)
SINGLE ACTING PIPING (BREAKER, ETC)
DOUBLE ACTING PIPING (CLAMSHELL, ETC)
BUCKET 0.07 M³

OPTIONAL EQUIPMENT

CERTIFIED CANOPY
BEACON LAMP
QUICK COUPLER
LONG ARM (1.35 M)
HEATER & DEFROSTER
RADIO / USB PLAYER
PATTERN CHANGE VALVE
ADDITIONAL COUNTERWEIGHT
QUICK COUPLER PIPING
DOUBLE ACTING PROPORTIONAL PIPING
ROTATION PROPORTIONAL PIPING
BIO OIL
CUSTOMIZED PAINTING
CABIN LIGHT
CENTRAL GREASING SYSTEM

* Standard and optional equipment may vary. Contact your Hyundai dealer for more information. The machine may vary according to International standards.
 * The photos may include attachments and optional equipment that are not available in your area.
 * Materials and specifications are subject to change without advance notice.



Specifications and design are subject to change without notice. Pictures of Hyundai Construction Equipment Europe products may show other than standard equipment.

Hyundai Construction Equipment Europe nv, Hyundailaan 4, 3980 Tessenderlo, Belgium. Tel: (32) 14-56-2200 Fax: (32) 14-59-3405

EN – 2021.01 Rev 0

Ready to experience the Hyundai Effect?

Contact your Hyundai dealer.
hyundai-ce.eu/en/dealer-locator