



MANITOU
GROUP

ATTACHMENT CATALOGUE

COMPLETE

December 6, 2023

MANITOU
GROUP | **ATTACHMENTS**

SET THE WORLD IN MOTION

Founded over 60 years ago by the Braud family, the Manitou Group now operates worldwide. A world-leader in all-terrain material handling, the Group designs, manufactures, distributes and services equipment for construction, agriculture and industries.

The Group's product ranges include: all-terrain fixed, rotating and heavyload telehandlers; all-terrain, semi-industrial and industrial masted forklift trucks; wheel or track skid-steer loaders; articulated loaders; access platforms; truck-mounted forklifts; warehousing equipment; and attachments.

Through its iconic brands - Manitou, Gehl- and its worldwide network of 1,050 dealers, the Group offers the best solutions to create optimum value for its customers.

Headquartered in France, the Group registered a revenue in 2021 of 1.9 billion euros in 140 countries and employs 4,500 people, all strongly focused on satisfying customers.



2 brands

distributed by 1050 dealers in 140 countries



- 32 subsidiaries
- 10 production sites
- 4,500 employees worldwide
- 64% of the share capital held by the founding families
- 82% of revenue comes from international sales
- 1.9 billion euros of turnover in 2021



MANITOU is pleased to present you this new version of its attachment catalogue. It will give you a complete view on the wide variety of original, homologated attachments marketed by Manitou for its telehandlers and forklift trucks.

Being simultaneously a producer of telehandlers and a producer of attachments, Manitou has the technical knowledge, the practical experience and the required facilities to control and ensure perfect efficiency of each attachment + machine pairing.

Manitou applies a demanding internal procedure that leads to the homologation of each attachment + machine pairing. This unique procedure brings guaranteed safety and unbeatable efficiency. Choosing a homologated original Manitou attachment and respecting Manitou's compatibilities, you can be sure you'll get the best of your machine, making no compromise with safety and staying in line with the European regulation.

We trust you'll find everything you need in this catalogue. Should you need something we haven't added to our offer yet, do contact your nearest Manitou dealer: our special solution department will certainly be able to craft the right tailor-made solution for you!

All attachments capacities given in this document are nominal capacities:

- Bucket capacities are calculated according to the ISO 7546 norm: they correspond to the heaped bucket capacity in m3 calculated according to the norm
- Grab bucket capacities given are total capacities with closed grab (in m3)
- Concrete mixing bucket, silage facing bucket, feeding bucket, shear grab & shear bucket as well as concrete & crane skip capacities are given in l and calculated to guarantee a good efficiency of all functions (no struck capacities)
- Sweeper capacities are max. dirt container capacities
- Platform capacities are given in kg INCLUDING 2 or 3 people (according to platform type)
- All other capacities are SWL (Safe Working Load) - in kg
- All compatibilities are given for the machines available for sales when this guide was issued. For machines produced earlier please contact your Manitou dealer.

Compatibility

Having legibility in mind we have simplified the list of machines in this guide. It should be read as follows:

- All compatibilities are given for the machines present in Manitou's offer on the guide's issuing day.
- For older machines please contact your Manitou dealer.

Material densities weights

Material	kg/m ³	Material	kg/m ³
Apples	525	Manure (farmyard)	922
Ashes	604	Nitrate fertiliser	1250
Barley	600	Oats	415
Beet pulp (nuts)	604	Onions	556
Beet pulp (pressed)	906	Peat (dry)	400
Brewers grain	1110	Petroleum coke	680
Brick aggregate	1828	Potatoes	699
Carrots	636	Refuse (town)	318
Cement (Portland)	1440	Rubble	1047
Cement (natural)	874	Sand (dry)	1550
Chalk	795	Sand (wet)	1890
Clay (fine)	2080	Sawdust	238
Clay (wet)	1680	Silage (ensile)	747
Coal (anthracite)	1046	Silage (green)	349
Coal (bituminous)	765	Slurry	1780
Coke (loose)	570	Snow (fresh)	200
Earth (dry)	1150	Snow (wet)	400
Fertiliser (mixed)	1030	Sodium chloride (dry salt)	1300
Flour	445	Straw (high density bale)	254
Gravel (dry)	1650	Sugar beet	530
Hay (normal density bale)	190	Turnips	540
Lime (quick)	881	Wheat	730
Limestone (crushed)	1530		

MINING SOLUTIONS

Range



- 304 Cylinder Handler
- 306 Pipe Handler
- 308 Slim Tyre Handler

- 311 Tunneling Platform
- 314 Tyre Handler
- 316 Underground Mining Platform





CYLINDER HANDLER



- For cylinders with diameter from 0 mm to 630 mm.
- Maximum capacity up to 10500 kg.
- Cylinder holding with cables (CH 4) or clamps (CH 10).
- Hydraulic movements: body rotation, side shift.
- CH4: Body rotation 22.5°, side shift 150 mm, hydraulic telescopic extension, hydraulic side body tilt 15°/15°, head rotation 35°.
- CH10: body rotation 340°, head vertical tilt 90°.
- CH10: clamping pressure alarm & pressure gauge on each front & side.
- Clamp reduction pads for smaller cylinders.
- Efficient & safe cylinder handling solutions.
- Faster, safer maintenance leading to less production losses.
- Robust conception designed for mining sites conditions.
- Safety & Productivity: smooth and accurate cylinder catching and positioning.
- Permanent cylinder grip: no suspended load, no risk of sudden slippage or fall.
- As functional as a human wrist.



	CH 4	CH 10
Max. outreach (mm)	2221	2500
Capacity (kg)	4000	10500
Overall weight (kg)	1850	3400
Overall height (mm)	1360	1195
Overall length (mm)	2249	2525
Width (mm)	1470	1780
Diameter minimum / Diameter maximum (mm)	250 / 530	230 / 640
Machine Equipment		
Rotation 1 (°)	22.50	340
Rotation 2 (°)	35	90
Side shift (mm)	150	300

Machines compatibility

Reference number E-RECO	911968	939239
MHT 790 ST5	X	-
MHT 10135 ST5	X	X
MHT 10160 ST5	X	X
MHT 10200 ST5	X	X
MHT 11250 ST5	X	X
MHT 12330	X	X
MHT-X 790 Mining	X	-
MHT-X 790 ST3A	X	-
MHT-X 10135 ST3A	X	X
MHT-X 10160 ST3A	X	X
MHT-X 10200 ST3A	X	X
MHT-X 11250 Mining	-	X
MHT-X 11250 ST3A	X	X
MHT-X 12330	X	X



PIPE HANDLER





- Maximum capacity 14000 kg / 30865 lbs.
- Max. pipe diameter 1016 mm / 40".
- Increased component protection for less downtimes.
- Complete grapple opening, increased efficiency when loading palletized loads.
- Rubber-covered tine pads.
- Fork dimensions: 120 x 240 x 2400 mm / 4.7 x 9.4 x 94.5".
- Thinner forks (90 mm) available upon request.
- Forks can be used in floating or fixed mode.

- Increases working safety & output on all pipe-handling applications.
- Perfect upholding of pipes thanks to its mobile grapple with hydraulic tine pads- increased safety on rough terrain.
- "Appendix" at the end of the grapple, ensures complete closing & prevents the pipes from sliding away.
- Separated control of grapple & tine pads for more accuracy.
- Increased polyvalence: can be used to handle other loads.

[The 3D picture at the top of this page is the reference PH 2100 / 8000 - 939231].

•



	PH 2100 / 8000	PH 2500 / 14000
Distance to center of gravity (mm)	586	891
Capacity (kg)	8000	14000
Overall weight (kg)	2200	3800
Overall length (mm)	2143	3104
Forks section X Forks width X Forks length (mm)	70 X 260 X 1200	120 X 240 X 2400
Width (mm)	2115	2444
Closed grab height (mm)	1387	2068
Opened grab height (mm)	3286	4699
Diameter minimum / Diameter maximum (mm)	566 / 850	0 / 1016
Machine Equipment		

Machines compatibility		
Reference number E-RECO	939231	939332
MHT 790 ST5	X	-
MHT 10135 ST5	X	-
MHT 10160 ST5	X	-
MHT 10200 ST5	X	X
MHT 11250 ST5	-	X
MHT 12330	X	X
MHT-X 790 Mining	X	-
MHT-X 790 ST3A	X	-
MHT-X 10135 ST3A	X	-
MHT-X 10160 ST3A	X	-
MHT-X 10200 ST3A	X	X
MHT-X 11250 Mining	-	X
MHT-X 11250 ST3A	-	X
MHT-X 12330	X	X

MANDATORY MACHINE EQUIPMENT:  + 



SLIM TYRE HANDLER





- Maximum capacity up to 2900 kg/6939 lbs.
- Clamping with forks, 93mm thin.
- Accept a wide variety of tyre diameters.
- Compact design, centre of gravity stays close to the telehandler.
- Body rotation : $\pm 360^\circ$.
- Constant side shift : ± 100 mm.
- Control: from cab or remote control (MHT).

- A compact solution for all limited-access tyre removal operations.
- Fork-based concept (2 pairs of forks), suitable for underground mining trucks.
- Perfect tyre holding, fork covered with anti-slip material.
- Available on several telehandler types.
- Limited machine downtime.

[The 3D picture at the top of this page is the reference TH 35 / 2900 S - 939040].



	TH 33 / 2000 S	TH 35 / 2900 S
Capacity (kg)	2000	2900
Overall weight (kg)	1160	1345
Overall height (mm)	916	916
Overall length (mm)	1743	1841
Forks section (mm)	93	107
Width (mm)	1360	1650
Arm length (mm)	1149	1199
Diameter minimum / Diameter maximum (mm)	480 / 2100	650 / 2650
Machine Equipment		
Rotation 1 (°)	360	360
Side shift (mm)	100	100
Forks	4	4
Opening minimum (mm)	470	640
Opening maximum (mm)	2120	2700

Machines compatibility

Reference number	939039	939040
MT-X 733 Mining	X	-
MT-X 1033 Mining	X	-
MT-X 1033 A Mining	X	-
Reference number E-RECO	939039	939040
MHT 790 ST5	X	X
MHT-X 790 Mining	X	X
MHT-X 790 ST3A	X	X
MRT 2260	X	-
MRT 2570	X	-
MRT 2660	X	-
MRT 3060	X	-
MRT 3570	X	-
MRT 3570 ES	X	-
MRT-X 2260	X	-
MRT-X 2570	X	-
MRT-X 2660	X	-
MRT-X 3060	X	-
MRT-X 3570	X	-
MRT-X 3570 ES	X	-
Reference number E-RECO 2	52721340	-
MRT 2260	X	-
MRT 2260 e	X	-
MRT 2570	X	-
MRT 2660	X	-
MRT 2660 e	X	-
MRT 3060	X	-
MRT 3570	X	-

TH 33 / 2000 S	TH 35 / 2900 S
----------------	----------------

Machines compatibility		
MRT 3570 ES	X	-
MRT-X 2260	X	-
MRT-X 2570	X	-
MRT-X 2660	X	-
MRT-X 3060	X	-
MRT-X 3570	X	-
MRT-X 3570 ES	X	-

MANDATORY MACHINE EQUIPMENT: 



TUNNELING PLATFORM

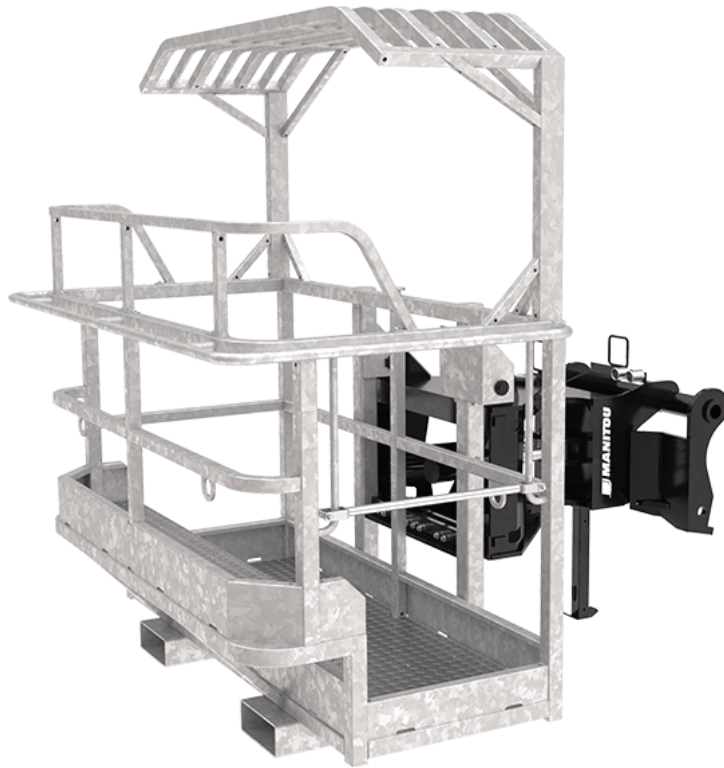



- Platform fitted with a FOPS-TYPE roof (length: 580mm / full platform width / 1930 mm under the roof).
- Protected elevated position (+ 300 mm).
- Capacity 1000 kg.
- Rotation 90° on both sides.
- Access: sliding bar on one side.
- Fork sleeves for yard handling.

- Maximum protection for tunneling applications
- No unsafe climbing on the platform required to work above the FOPS roof.
- To use heavy tools in the platform.
- No compromise on safety: EN 280 compliant.

[The 3D picture at the top of this page is the reference GALLERY PLATFORM - 921356].



	GALLERY PLATFORM	PST 1800 / 1000 3P FOPS1
Number of people	3	3
Capacity (kg)	1000	1000
Overall weight (kg)	730	730
Overall height (mm)	2125	2125
Overall length (mm)	2175	2175
Width (mm)	1990	1990
Depth (mm)	1000	1000
Machine Equipment		
Rotation 1 (°)	90	90
Rotation 2 (°)	90	90

Machines compatibility		
Reference number	-	52574289
MT-X 1033 A Mining	-	X
Reference number E-RECO	921356	52719262
MHT 790 ST5	-	X
MHT 10135 ST5	-	X
MHT 10160 ST5	-	X
MHT 10200 ST5	-	X
MHT 11250 ST5	-	X
MHT-X 790 Mining	-	X
MHT-X 790 ST3A	-	X
MHT-X 10135 ST3A	-	X
MHT-X 10160 ST3A	-	X
MHT-X 10200 ST3A	-	X
MHT-X 11250 ST3A	-	X
MRT 1645 75	X	X
MRT 1645 115	X	X
MRT 1845 75	X	X
MRT 1845 115	X	X
MRT 2145 115	X	X
MRT 2260	X	X
MRT 2260 e	-	X
MRT 2545 115	-	X
MRT 2570	X	X
MRT 2660	X	X
MRT 2660 e	-	X
MRT 3060	X	X
MRT 3570	X	X
MRT 3570 ES	X	X
MRT-X 1645	X	X
MRT-X 1845	X	X
MRT-X 2145	X	X
MRT-X 2260	X	X

GALLERY PLATFORM	PST 1800 / 1000 3P FOPS1
-------------------------	---------------------------------

Machines compatibility		
MRT-X 2545	-	X
MRT-X 2570	X	X
MRT-X 2660	X	X
MRT-X 3060	X	X
MRT-X 3570	X	X
MRT-X 3570 ES	X	X

MANDATORY MACHINE EQUIPMENT: 







TYRE HANDLER



- Safe solution for tyre removal in mining environments.
- Complex hydraulic movements: body rotation, pad rotation, side shift+ machine tilt & telescope extension.
- Safety: anti-fall arms.
- Telescopic (TH 49) or parallelogram kinematics (all other clamps).
- Controlled from the cab or with a remote control.
- Safety: each movement activated by 2 operator actions (button + joystick).
- TH 49/ 2500: 1 left pad active, right pad passive.
- Tyre changes made fast & safe.
- Significant improvement in tyre changing operations.
- No compromise with safety.
- As mobile as a human wrist.
- Wide range of diametres & capacities to suit all dump truck.
- Available on a wide range of machines.

[The 3D picture at the top of this page is the reference TH 49 / 2500 - 914600].



	TH 49 / 2500	TH 51 / 3500	TH 57 / 6000**	TH 63 / 12000**
Distance to center of gravity (mm)	618	993	1135	1225
Max. outreach (mm)	1903	2610	2991	3837
Capacity (kg)	2500	3500	6000	12000
Overall weight (kg)	1500	3300	4300	5260
Overall height (mm)	1050	1229	1229	1229
Overall length (mm)	2208	2990	3371	3752
Width (mm)	1951	2392	2500	3224
Depth (mm)	1214	2251	2683	2333
Diameter minimum / Diameter maximum (mm)	1200 / 3100	1200 / 3400	1300 / 3800	600 / 4200
Machine Equipment				
Rotation 1 (°)	20	35	172	172
Rotation 2 (°)	120	120	360	360
Side shift (mm)	200	150	300	300
Opening minimum (mm)	1146	1128	1218	549
Opening maximum (mm)	3146	3416	3831	4286

Machines compatibility

Reference number E-RECO	914600	911969	939237	939331
MHT 790 ST5	X	X	-	-
MHT 10135 ST5	-	X	-	-
MHT 10160 ST5	-	X	-	-
MHT 10200 ST5	-	-	X	X
MHT 11250 ST5	-	-	X	X
MHT 12330	-	X	X	X
MHT-X 790 Mining	X	X	-	-
MHT-X 790 ST3A	X	X	-	-
MHT-X 10135 ST3A	-	X	-	-
MHT-X 10160 ST3A	-	X	-	-
MHT-X 10200 ST3A	-	-	X	X
MHT-X 11250 Mining	-	-	X	X
MHT-X 11250 ST3A	-	-	X	X
MHT-X 12330	-	X	X	X

MANDATORY MACHINE EQUIPMENT: 



UNDERGROUND MINING PLATFORM







- Robust and shielded structure with multiple protective bumpers
- Legaly aproved for 3 people
- Plain floor or meshed floor.

- Solution for specific applications in mining.
- Maximum safety when lifting people.

[The 3D picture at the top of this page is the reference PF 2000 / 1200 D MINING - 914730].



	PF 2000 / 1200 D MINING	PF 2000 / 1200 D MINING (b)	PF 2000 / 1200 D MINING (US CA NZ AUS)	PF 2000 / 1200 D MINING (US CA NZ AUS) (b)
Distance to center of gravity (mm)	1035	1035	1035	1035
Number of people	3	3	3	3
Capacity including people (kg)	1200	1200	1200	1200
Overall weight (kg)	1150	1150	1150	1150
Overall height (mm)	1922	1922	1922	1922
Overall width (over tyres) (mm)	2246	2246	2246	2246
Width (mm)	2000	2000	2000	2000
Depth (mm)	1300	1300	1300	1300
Machine Equipment				

Machines compatibility

Reference number	914730	-	-	-
MT-X 1033 A Mining	X	-	-	-
Reference number E-RECO	52727778	52746231	52747070	52746962
MHT 790 ST5	-	X	-	X
MHT 10135 ST5	X	-	X	-
MHT 10160 ST5	X	-	X	-
MHT 10200 ST5	X	-	X	-
MHT 11250 ST5	X	-	X	-
MHT-X 790 Mining	-	X	-	X
MHT-X 790 ST3A	-	X	-	X
MHT-X 10135 ST3A	X	-	X	-
MHT-X 10160 ST3A	X	-	X	-
MHT-X 10200 ST3A	X	-	X	-
MHT-X 11250 Mining	X	-	X	-
MHT-X 11250 ST3A	X	-	X	-

MANDATORY MACHINE EQUIPMENT: 

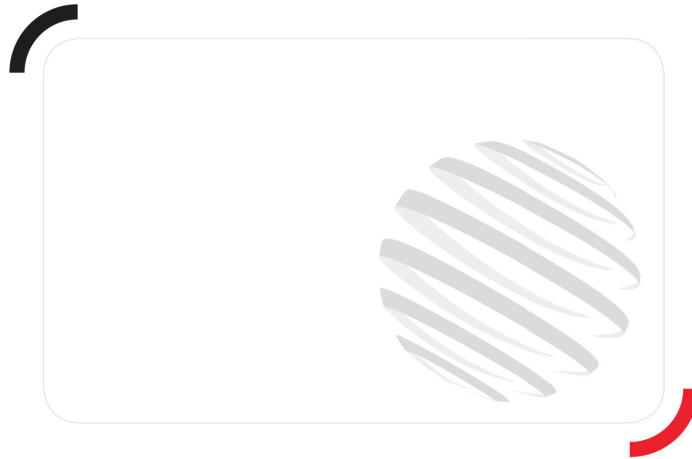

MANITOU GROUP ATTACHMENTS

Head Office

B.P. 249 - 430 rue de l'Aubinière

44150 Ancenis Cedex - France

Tel: +33 (0)2 40 09 10 11 - Fax: +33 (0)2 40 09 10 97

www.manitou.com



This publication provides a description of the configuration versions and options for Manitou products, which may differ for equipment. The equipment presented in this brochure may be part of a series, as an option, or it may not be available, depending on the versions. Manitou reserves the right, at any time and without notice, to amend the specifications described and represented. The specifications provided do not bind the manufacturer. For more details, please contact your Manitou agent. This is not a contractually binding document. The presentation of the products is not contractually binding. List of specifications non-exhaustive. The logos as well as the visual identity of the company are owned by Manitou and cannot be used without authorisation. All rights reserved. The photos and diagrams contained in this brochure are only provided for consultation and information purposes.

MANITOU BF SA - Limited company with board of directors - Share capital: 39,668,399 euros - 857 802 508 RCS Nantes