

Technical sheet

MC 25-4

Masted Forklift Trucks



Technical characteristics		Metric
1.1	Manufacturer	Manitou
1.2	Model	MC 25-4
1.3	Type of traction	Diesel
1.4	Type of operation	Seated
1.5	Q - Rated capacity	2500 kg
1.6	c - Center of gravity of load	500 mm
1.8	x - Distance from the load bearing surface to the centre of the front axle	621 mm
1.9	y - Wheelbase	1900 mm
Weight		
2.1	Weight of truck in working order	4035 kg
2.2	Laden weight on front/rear axle	5550 kg / 985 kg
2.3	Unladen weight on front/rear axle	1575 kg / 2460 kg
Wheels		
3.1	Tyre equipment: bandage (V), PPS (SE), inflatable tyre (L)	L
3.2	Size of front wheels	15.2/80-18/12SLR4
3.5	Number of front wheels (x)	2x / 2x
3.6	b10 - Front track	1.16 mm
3.7	b11 - Rear track	1.18 mm
Dimensions		
4.1	α / β - Front/Rear mast angle	10 ° / 12 °
4.2	h1 - Height (mast lowered)	1990 mm
4.3	h2 - Free lift	90 mm
4.4	h3 - Lift height (Duplex mast)	3300 mm
4.5	h4 - Height of extended mast	4156 mm
4.7	h6 - Height of driver protection (cab)	2155 mm
4.8	h7 - Height of seat	1094 mm
4.19	l1 - Total length	4195 mm
4.20	l2 - Length to fork heel	3045 mm
4.21	b1 - Overall width - Single/twinned wheels	1450 mm / -
4.22	e / s / l - Fork dimensions	1150 X 122 X 45
4.23	Fork carriage to DIN 15173 A/B	FEM 2A
4.24	b3 - Width of fork clamp	1260 mm
4.31	m1 - Ground clearance under mast	300 mm
4.33	Ast - Aisle width for 1000 x 1200 pallet widthwise	5376 mm
4.35	Wa - Turning radius	3405 mm
Performances		
5.1	Speed of travel laden / unladen	12 km/h / 25 km/h
5.2	Lifting speed laden / unladen	0.47 m/s / 0.46 m/s
5.3	Lowering speed laden / unladen	0.50 m/s / 0.30 m/s
5.7	Maximum ramp laden / unladen	23 % / 26 %
5.10	Service brake	Hydraulic
Engine		
7.1	Engine manufacturer / Type	Kubota / Stage 3A
7.2	Useful power	36.50 kW
7.3	Rated speed	2700 rpm
7.4	Number of pistons / Capacity	4 / 2434 cm ³
7.5	Fuel consumption according to VDI cycle	6 l/h
Miscellaneous		
8.3	Oil flow rate for attachments	57 l/min

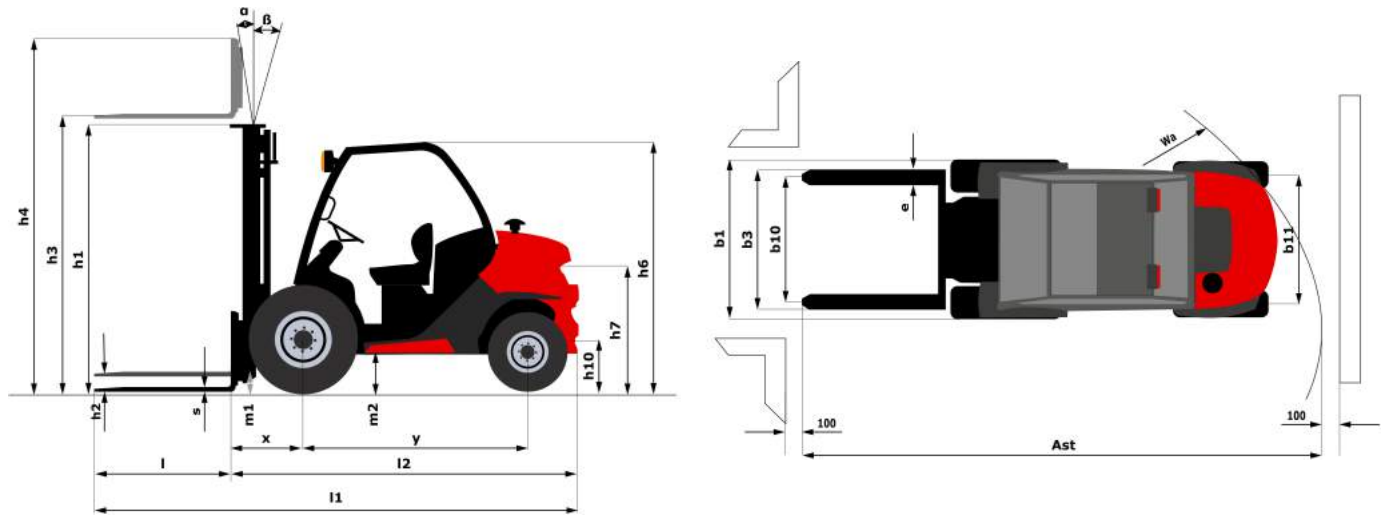

Characteristics of masts and residual capacities

Full Visibility Triplex		FVT33
Lift height	mm	3300
Height (mast lowered)	mm	1880
Free lift	mm	0
Height of extended mast	mm	4115
Forward/backward mast tilt angle	°	10 / 12

Full Visibility Duplex	FVD30	FVD35	FVD40	FVD55	FVD60	FVD27
Lift height	3000	3500	4000	5500	6000	2700
Height (mast lowered)	2190	2440	2790	3540	3830	2040
Free lift	90	90	90	90	90	90
Height of extended mast	3876	4376	4876	6376	6876	3576
Residual Capacity without attachment (Industrial load chart)	2500					2500
Forward/backward mast tilt angle	10 / 12		10 / 12	6 / 6	6 / 6	10 / 12

Duplex Total Visibility	FVD 33	FVD 37	FVD 45
Lift height	3300	3700	4500
Height (mast lowered)	2340	2600	3040
Free lift	90	90	90
Height of extended mast	4176	4576	5376
Residual Capacity without attachment (Industrial load chart)	1650		
Forward/backward mast tilt angle	10 / 12	10 / 12	10 / 12

Free Lift Triplex		FLT60	FLT65	FLT70
Lift height	mm	6000	6500	7000
Height (mast lowered)	mm	2790	3040	3290
Free lift	mm	2016	2266	2516
Height of extended mast	mm	6814	7314	7814
Forward/backward mast tilt angle	°	6 / 6	6 / 6	6 / 6

Triplex Without Free Lift		FVD50
Lift height	mm	5000
Height (mast lowered)	mm	3290
Free lift	mm	90
Height of extended mast	mm	5876
Forward/backward mast tilt angle	°	6 / 6

Triplex Free Lift		FLT 37	FLT 40	FLT 43	FLT 47	FLT 50	FLT 55
Lift height	mm	3700	4000	4300	4700	5000	5500
Height (mast lowered)	mm	1990	2090	2190	2340	2440	2600
Free lift	mm	1216	1316	1416	1566	1666	1826
Height of extended mast	mm	4514	4814	5114	5514	5814	6314
Forward/backward mast tilt angle	°	10 / 12	10 / 12	10 / 12	10 / 12	6 / 6	6 / 6



Siège Social
430 rue de l'Aubinière - 44150 Ancenis Cedex - France
Tel: +33(0)2 40 09 10 11 - Fax: +33 (0)2 40 09 10 97
www.manitou.com



This brochure describes versions and configuration options for Manitou products which may be fitted with different equipment. The equipment described in this brochure may be standard, optional or not available depending on version. Manitou reserves the right to change the specifications shown and described at any time and without prior warning. The manufacturer is not liable for the specifications given. For more information, contact your Manitou dealer. Non-contractual document. Product descriptions may differ from actual products. List of specifications is not comprehensive. The logos and visual identity of the company are the property of Manitou and may not be used without authorisation. All rights reserved. The photos and diagrams contained in this brochure are provided for information only.

MANITOU BF SA - Limited company with board of directors - Share capital: 39,547,824 euros - 857 802 508 RCS Nantes