

MOVING YOU FURTHER

# HL965

With Tier 4 final / Stage IV Engine installed



\* Photo may include optional equipment.

**Net Power**

201 kW (269 hp) / 2,100 rpm

**Gross Power**

203 kW (272 hp) / 2,100 rpm

**Travel Speed**

40.0 km/h (24.9 mph)

**Operating Weight**

20,100 kg / 44,315 lb



# RULE THE GROUND

The HL900 Series wheel loaders are products of HHI's spirit of initiative, creativity, and strong drive. HHI's engineering experts have worked tirelessly to offer a zero-defect product. The new HL900 Series reflects customers' needs in the field gleaned by thorough monitoring. They maximize performance proven by rigorous field tests and quality control. The HL900 Series exceeds customers' expectations! Become a true leader on the ground with HHI's HL900 Series.





**HYUNDAI**

\* Photo may include optional equipment.

# RULE THE GROUND

The HL900 series exceeds customers' expectation!  
Become a true leader on the ground with HHI's HL900 series.



## WORK MAX, WORTH MAX

- Accurate Onboard Weighing System
- ECO Gauge
- ECO Pedal
- Electro-Hydraulic Control
- Automatic Shut-Down of Engine (Only Button Key)
- 5 Speed Lock-up Clutch
- ICCO (Intelligent Clutch Cut-off)
- Hydraulic Lock Differential
- Thermostat for Transmission Cooling
- Load Sensing Hydraulics



## MORE RELIABLE, MORE SUSTAINABLE

- Durable Structure for After-Treatment
- Improved Bucket Fill Factor
- Sinter Brake Disc
- Premium Quality Axles
- Hydraulic Hose
- Sealed Drive Line Center Bearing
- Axle Oil Cooling System (Option)



# HL965



## INFOTAINMENT FRONTIER

- Intelligent & Wide Touch Screen Monitor
- Centralized Cluster
- Audio System
- Wifi Direct With Smart Phone (Smart Terminal)



## MODERN COMFORT, SIMPLE AND SAFE SOLUTION

- Fully Sealed Engine Room & Fully Openable
- Fully Adjustable Seat Armrest, Seat
- Full Sound-Proofed Spacious Cabin
- Electro-Hydraulic Implement Control
- New Air Conditioning System
- Increased Service Life for Engine Air Filter
- Soft end Stop
- LED lamp (Option)
- Ride Control System



\* Photo may include optional equipment.



\* Photo may include optional equipment.



### Accurate Onboard Weighing System

All Hyundai HL900 series models include Hyundai's proprietary onboard weighing system as standard equipment. Accurate to +/- 1 percent, the system has automatic and manual settings for monitoring individual and cumulative bucket load weights. System measurements are displayed on the multi-function screen in the cab, providing load-weight monitoring reliable enough to support production management.

# WORK MAX, WORTH MAX

## Tier 4 Final Engine Technologies

Hyundai HL900 series wheel loaders incorporate new engine technologies for Tier 4 Final compliance and include many new features that contribute to overall fuel and production efficiency.



### ECO Gauge

Using this function, the operator can monitor fuel consumption in real time or review historical data. Displayed values include engine torque, fuel efficiency, average and total fuel consumed. Hourly and daily fuel consumption also is viewable through the menu.



### ECO Pedal

The innovative Eco Pedal helps the operator work as efficiently as possible. When working the engine throttle between zero and 85 percent of full power, fuel savings are maximized. For those tough jobs, the operator easily commands maximum performance by applying additional pressure on the Eco Pedal to gain up to 100 percent of available engine power.



### Electro-Hydraulic Control

With improved precision and operability, the electro-hydraulic control system of the HL900 Series provides diverse functions and easy handling to control any working conditions, increasing productivity and reducing fatigue of operators.

\* Fine operation/bucket priority / Auxiliary attachment max flow / Soft end stop



### Automatic Shut-Down of Engine (Only Smart Key)

This system turns the engine when entering idle state to minimize unnecessary fuel consumption and emissions. Operators can select the operating mode and idle time, depending on the work condition, which contributes to overall fuel efficiency.



### 5 Speed Lock-up Clutch

With the five-speed transmission and lockup clutch, operators can select the appropriate gear for their work conditions, thereby reducing fuel consumption.

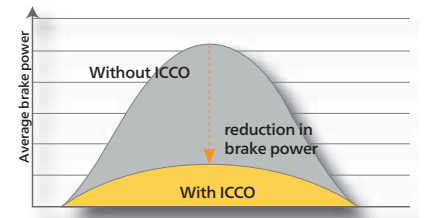

### ICCO (Intelligent Clutch Cut-off)

By selecting of H-mode, it will be engaged for minimizing the loss of power on torque converter and reducing the damage. The ICCO restrains generation of heat that improves overall durability of brake disk.



### Hydraulic Lock Differential

Hydraulic Lock Differential has the advantages of both improving productivity and less fuel consumption by preventing tire slip during the operation.

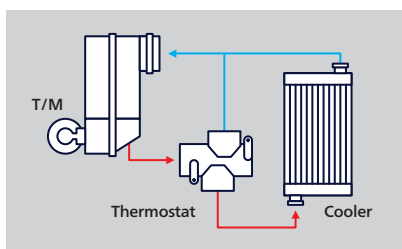

### Thermostat for Transmission Cooling

With thermostat for transmission cooling, temperature of fluid increases rapidly and remains at optimal temperature during winter season, thereby achieving quick warm, protection of functional parts, and the higher efficiency.

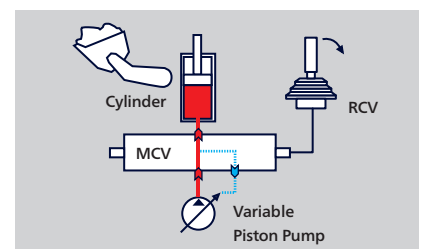

### Load Sensing Hydraulics

With precise load sensing and the higher efficiency on control of piston pump, the load sensing contributes to reduce the fuel consumption by discharging the minimum oil pressure and flow.

# MORE RELIABLE, MORE SUSTAINABLE

## New Exterior Design for More Robustness and Safety

The true value of the HL900 Series, which is now far more powerful, is revealed in tough working environments. With the high-strength design structure and enduring system proven by rigorous road tests at various work sites, Hyundai's wheel loaders can perform any high-load work to maximize productivity. Durability of frames and attachments have been enhanced by 1.5 times compared to the previous generation 9-series.



### Durable Structure for After-Treatment

HL965 wheel loaders are equipped with a robust support and shock absorbing system to prevent failure of after-treatment system components during operation.

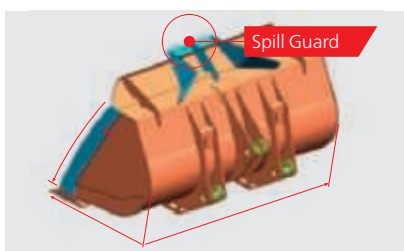

### Improved Bucket Fill Factor

Hyundai's improved bucket design features an innovative wider opening, curved side plates and enhanced spill guard to maximize bucket capacity and minimize material loss when traveling. Durability is also enhanced through the use of high wear-resistant steel in key structural areas of the bucket.



### Sintered Brake Disc

The HL900 series features longer-lasting sintered brake discs designed to produce less heat and vibration, which improves overall brake durability. This service-friendly design contributes to reduced downtime for brake maintenance and reduces overall cost of ownership.



### Premium Quality Axles

An enhanced axle improves driving over variable ground conditions.



### Hydraulic Hose

Hyundai provides high quality hydraulic hoses, which are three to four times more durable than other hoses commonly found in the industry.

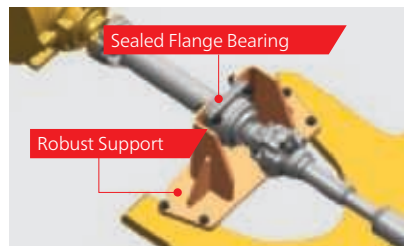

### Sealed Drive Line Center Bearing

Hyundai's wheel loaders are designed for extended service life. A sealed drive-line center bearing with a reinforced support area contributes to improved long-term reliability.





\* Photo may include optional equipment.

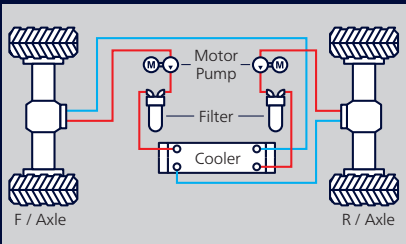

### Axle Oil Cooling System (Option)

A separate cooling system prevents overheating of axle oil caused by frequent braking and high-load work.



\*Photo may include optional equipment.

# INFOTAINMENT FRONTIER

## Enhanced Instrument Panel for Easier Monitoring

The HL900 Series is optimized to enable operators to access accurate equipment data in a timely manner. This feature is more important in tough working environments to increase productivity while enjoying various forms of entertainment. Enjoy unparalleled satisfaction provided by infotainment of HHI's state-of-the-art information technology!



## Intelligent & Wide Touch Screen Monitor

The seven-inch capacitive-type display (like a smart phone display) of the HL900 Series is larger than the previous model and provides excellent legibility. Audio AUX maximizes convenience of operators.



## Centralized Cluster

With the centralized icons on the display, operators are easily aware the conditions and faults of machines.



## Audio System

The radio with MP3 functions, the integrated Bluetooth hands-free feature, and the built-in microphone allow for phone calls and for listening to music while in the field.



## Wifi Direct With Smart Phone (Smart Terminal)

The Miracast system connects to an operator's smartphone via the phone's Wi-Fi. This enables operators to view their phone screen on the monitor for web surfing, videos and/or music.

# MODERN COMFORT, SIMPLE AND SAFE SOLUTION

## New Cabin for More Comfort

With top priority on satisfaction of operators in terms of silence, safety, and maintainability, Hyundai's wheel loaders provide comfortable cabin space for operators by low-vibration, low-noise, and superior safety design. They also offer greater satisfaction by extending the replacement cycle of supplies and minimizing maintenance time and cost.



### Fully Sealed Engine Room & Fully Openable

The HL900 series has improved accessibility to the sealed engine room with a tilt-back hood to allow for easy cleaning and maintenance. The engine compartment is designed to prevent any possibility of fire due to contamination. The wide open access when the hood is open also enhances serviceability of the engine and cooling room.



### Fully Adjustable Seat Armrest, Seat

HL965 wheel loader is equipped with large, comfortable, high-quality seats with headrests. The armrest and controller are mounted to the seat so they move with the operator, which improves comfort and reduces fatigue.



### Full Sound-Proofed Spacious Cabin

The state-of-the-art noise reduction technology found on the HL900 series models results in one of the quietest working environments in the industry. In-cab sound levels are as low as 70 dB.



### Electro-Hydraulic Implement Control

Hyundai's wheel loaders have an electro-hydraulic implement control lever. Operators can operate attachments with less strength, enabling greater productivity and minimizing fatigue of operators. (Roller switch for AUX SPOOL Control).



### New Air Conditioning System

Hyundai's wheel loaders have optimized air flow to maximize heating and cooling performance. The air conditioning system is located on the right side of the cab to allow for easier maintenance and filter replacement. The capacity of the inner filter also is increased. Filter material is improved for superior filtering performance.

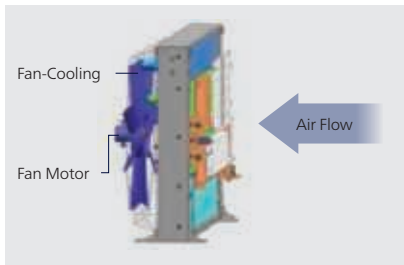

### Increased Service Life for Engine Air Filter

The HL965 has a durable wide fin cooler preventing performance degradation caused by alien substances. The HL965 is equipped with the reversal fan to eliminate many kinds of debris.



### Soft end Stop

This function reduces the hydraulic speed of the cylinder as it reaches the end of its stroke. This lessens the shock load of the stroke, which improves material retention, while increasing operator comfort and productivity.



\* Photo may include optional equipment.



### LED lamp (Option)

Machine is applied with LED lights on all working lamp positions (front and back, head light, beacon lamp, rear combi light). Lifetime of lamps will be 40 times longer than before. Additional benefit is a reduction of 70% energy consumption (to halogen lamps).

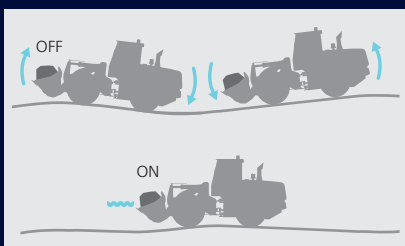

### Ride Control System (Option)

Ride control system with piston accumulator, which reduces the pitch of body and bucket of wheel loader, minimizes spillover and contributes to increase convenience.



# SPECIFICATIONS

ENGINE		
Engine / Model	Cummins / QSL9	
Maximum Gross Power ( 2,100 rpm)		
SAE J1995	203 kW	272 hp
Maximum Net Power (2,100 rpm)		
SAE J1349	201 kW	269 hp
Peak Gross Torque (1,400 rpm)		
SAE J1995	1451 N·m	1,070 lbf·ft
Maximum Net Torque (1,400 rpm)		
SAE J1349	1432 N·m	1,056 lbf·ft
Bore	114 mm	4.49 in
Stroke	145 mm	5.71 in
Displacement	8.9 l	543 in <sup>3</sup>

- The indicated net power is available for the flywheel when the engine is equipped with a fan, alternator, air cleaner, and after-treatment device.
- The indicated gross power is obtained with the fan at maximum speed.

TRANSMISSION					
Travel speed		4 speed T/M		5 speed T/M with lock up clutch	
		km/h	mph	km/h	mph
Forward	1st	6.0	3.7	6.3	3.9
	2nd	11.4	7.1	11.1	6.9
	3rd	22.9	14.2	17.1	10.6
	4th	37.4	23.2	26.6	16.5
	5th	-	-	40	24.9
Reverse	1st	6.3	3.9	6.7	4.1
	2nd	12.0	7.4	11.7	7.3
	3rd	24.2	15.0	28.0	17.4

- This is the maximum travel speed of a standard machine with unfilled bucket.

AXLES	
Front	Fixed
Rear	Oscillating ±12 degrees

OVERVIEW				
Description	UNIT	HL965	HL965XT	
Operating weight	kg	20,100	20,960	
	lb	44,315	46,210	
Bucket capacity	Heaped	m <sup>3</sup>	3.60	3.60
		yd <sup>3</sup>	4.71	4.71
	Struck	m <sup>3</sup>	3.10	3.10
		yd <sup>3</sup>	4.05	4.05
Breakout force-bucket	kg	17,400	17,265	
	lb	38,360	38,060	
Tipping load	Straight	kg	14,700	13,400
		lb	32,410	29,545
	Full turn	kg	12,720	11,520
		lb	28,045	25,400

TIRES	
Type	Tubeless, loader design tires
Standard	23.5 R25, L3
Options include	23.5, R25, XHA2 23.5-25, 20PR, L3 23.5-25, 20PR, L5

BRAKES	
Service Brakes	Hydraulically actuated, wet disc brakes actuate all 4 wheels, independent axle-by-axle system. Self adjusting & wheel speed brake.
Parking Brake	Spring applied, hydraulic released brake
Emergency Brake	When brake oil pressure drops, indicator light alerts operator and parking brake automatically applies.

HYDRAULIC SYSTEM		
Implement Pump Type	Load sensing hydraulic system	
Implement System		
Maximum Pump Output (2,130 rpm)	249 l/min	65.8 gal/min
Maximum Operating Pressure	28000 kPa	4,061 psi
Hydraulic Cycle Time with Rated Payload	Raise from Carry Position 5.8 Sec.	
	Dump, at Maximum Raise 1.4 Sec.	
	Lower, Empty, Float Down 3.1 Sec.	
	Total	10.3 Sec.
Cylinder	Type : Double acting	
	No. of cylinders-bore x stroke;	
	Lift	mm 2-140 x 785 in 2-5.5 x 30.9
	HL965 Tilt	mm 1-160 x 560 in 1-6.3 x 22.0
	HL965XT Tilt	mm 1-160 x 560 in 1-6.3 x 22.0

STEERING SYSTEM	
Type	Load sensing hydrostatic articulated steering
Pump	Variable displacement piston pump, 132 l/min (34.9 gal / min)
System Pressure	25000 kPa
	3,626 psi
Cylinder	Double acting
	mm 2-75 x 424 in 2-2.9 x 16.7
Steering Angle	40° to both right and left angle, respectively

SERVICE REFILL CAPACITIES		
UNIT	l	Us gal
Fuel tank	300	79.2
DEF tank	27.0	7.1
Cooling system	44.0	11.6
Crankcase	19.0	5.0
Transmission	48.0	12.7
Front axle	42.0	11.1
Rear axle	40.0	10.6
Hydraulic tank	115	30.4
Hydraulic system (including tank)	215	56.8

CAB	
ROPS / FOPS meet ISO 3471 and ISO 3449 Level II standards	

SOUND	
Guaranteed Noise Level presented below can be differed depending on a range of factors such as operating condition, speed of a cooling fan, types of engine and so forth. Hearing protection shall be necessary if an operator is working in the improperly maintained cabin or exposed to a noisy environment by leaving doors and/or windows open.	
With Cooling Fan Speed at Maximum Value:	
Operator Sound Pressure Level (ISO 6396:2008)	70 dB(A)
Exterior Sound Power Level (ISO 6395:2008)	107 dB(A)

\* Distance of 15 m (49.2 ft), moving forward in second gear ratio.

# SPECIFICATIONS

## DIMENSIONS

All dimensions are approximate.

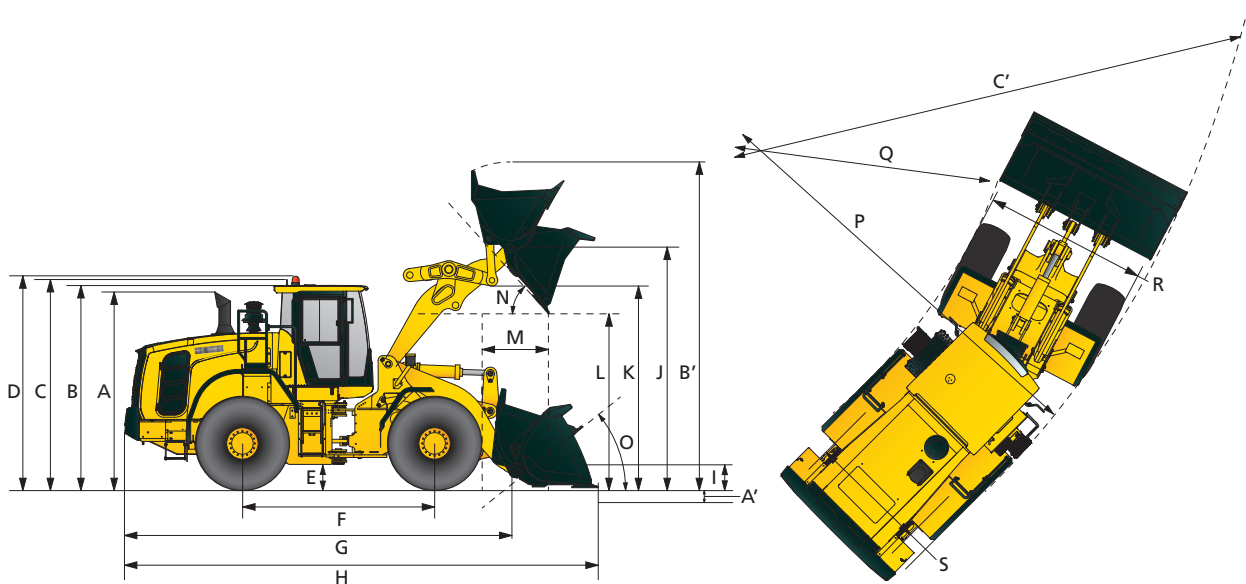

Description	HL965		HL965XT	
	mm	in	mm	in
A. Height to Top of Exhaust Pipe	3375	132.9	3375	132.9
B. Height to Top of Cabin	3450	135.8	3450	135.8
C. Height to Top of Product Link Antenna	3850	151.6	3850	151.6
D. Height to Top of Warning Beacon	3580	140.9	3580	140.9
E. Ground Clearance	410	16.1	410	16.1
F. Wheelbase	3300	130.0	3300	130.0
G. Overall Length (without bucket)	6980	274.8	7560	297.6
H. Shipping Length (with bucket level on ground)	8280	326.0	8850	348.4
I. Hinge Pin Height at Carry Position	480	18.9	615	24.2
J. Hinge Pin Height at Maximum Lift	4145	163.2	4630	182.3
K. Lift Arm Clearance at Maximum Lift	3485	137.2	3955	155.7
L. Dump Clearance at Maximum Lift and 45° Discharge	2955	116.3	3440	135.4
M. Reach at Maximum Lift and 45° Discharge	1400	55.1	1455	57.3
N. Dump Angle at Maximum Lift and Dump (on stops)	50	1.9	50	1.9
O. Roll Back Angle	Ground	42	1.6	42
	Carry	47	1.8	49
P. Clearance Circle (diameter) to Outside of Tires	12045	474.2	12045	474.2
Q. Clearance Circle (diameter) to Inside of Tires	6530	257.1	6530	257.1
R. Width over Tires (unloaded)	2760	108.7	2760	108.7
S. Tread Width	2160	85.0	2160	85.0

- A', B', C' are indicated on the next page



# SPECIFICATIONS

OPERATING SPECIFICATIONS WITH BUCKETS								
Linkage		Standard Linkage						High Lift Linkage
Bucket Type		General Purpose - Pin On						
Edge Type		Bolt-On Cutting Edges		1 Piece Tooth		2 Piece Tooth		
Capacity - Rated	m <sup>3</sup>	3.60	3.80	3.40	3.60	3.40	3.60	-
	yd <sup>3</sup>	4.71	4.97	4.45	4.71	4.45	4.71	-
Capacity - Rated at 110% Fill Factor	m <sup>3</sup>	3.96	4.18	3.74	3.96	3.74	3.96	-
	yd <sup>3</sup>	5.18	5.47	4.90	5.18	4.90	5.18	-
Width	mm	3000	3000	3050	3050	3070	3070	-
	ft / in	9' 10.1"	9' 10.1"	10' 0.1"	10' 0.1"	10' 0.9"	10' 0.9"	-
Dump Clearance at Maximum Lift and 45° Discharge	mm	2955	2920	2830	2795	2795	2760	+ 485
	ft / in	9' 8.3"	9' 7.0"	9' 3.4"	9' 2.0"	9' 2.0"	9' 0.7"	+ 1' 7.1"
Reach at Maximum Lift and 45° Discharge	mm	1400	1435	1485	1520	1505	1540	+ 55
	ft / in	4' 7.1"	4' 8.5"	4' 10.5"	4' 11.8"	4' 11.3"	5' 0.6"	+ 2.2"
A' Digging Depth	mm	90	90	115	115	125	125	+ 0
	ft / in	3.5"	3.5"	4.5"	4.5"	4.9"	4.9"	+ 0
Shipping Length (with Bucket)	mm	8280	8330	8430	8480	8470	8520	+ 570
	ft / in	27' 2.04"	27' 4.0"	27' 7.9"	27' 9.9"	27' 9.5"	27' 11.4"	+ 1' 10.4"
B' Overall Height with Bucket at Maximum Lift	mm	5700	5750	5700	5750	5700	5750	+ 485
	ft / in	18' 8.4"	18' 10.4"	18' 8.4"	18' 10.4"	18' 8.4"	18' 10.4"	+ 1' 7.1"
C' Loader Clearance Circle with Bucket at Carry Position	mm	13580	13610	13735	13765	13785	13815	+ 460
	ft / in	44' 6.6"	44' 7.8"	45' 0.7"	45' 1.9"	45' 2.7"	45' 3.9"	+ 1' 6.1"
Static Tipping Load, Straight (No Tire Deflection)	kg	14700	14600	14910	14830	14910	14830	- 1,300
	lb	32410	32185	32780	32695	32780	32695	- 2865
Static Tipping Load, Articulated (No Tire Deflection)	kg	12720	12630	12900	12830	12900	12830	- 1200
	lb	28045	27845	28440	28285	28440	28285	- 2645
Breakout Force	kg	17400	16755	18465	17745	18465	17745	- 135
	lb	38360	36940	40710	39120	40710	39120	- 300
Operating Weight*	kg	20100	20145	20015	20060	20015	20060	+ 860
	lb	44315	44410	44125	44225	44125	44225	+ 1895

\* All height and tire related dimensions are with standard 23.5 R25, L3 tires

# SPECIFICATIONS

## DENSITY OF OPERATING MATERIALS

		Material Density [ ton / m <sup>3</sup> ]
Earth/Clay		1.5 ~ 1.7
Sand and Gravel		1.5 ~ 1.7
Aggregate	25 ~ 76 mm (1" to 3 in)	1.6 ~ 1.7
	19 mm (0.75 in) and larger	1.8

## DENSITY OF OPERATING MATERIALS

Lift arm	Bucket	Type	m <sup>3</sup>	Material Density [ ton / m <sup>3</sup> ]																					
				0.8	0.9	1.0	1.1	1.2	1.3	1.4	1.5	1.6	1.7	1.8	1.9	2.0	2.1	2.2	2.3	2.4	2.5				
Standard lift arm	General Purpose	Cutting edge	3.6	4.1 m <sup>3</sup>										3.4 m <sup>3</sup>											
		Cutting edge	3.8	4.4 m <sup>3</sup>										3.6 m <sup>3</sup>											
		1-Bolt on tooth	3.4	3.9 m <sup>3</sup>										3.2 m <sup>3</sup>											
		1-Bolt on tooth	3.6	4.1 m <sup>3</sup>										3.4 m <sup>3</sup>											
		2-Bolt on tooth	3.4	3.9 m <sup>3</sup>										3.2 m <sup>3</sup>											
		2-Bolt on tooth	3.6	4.1 m <sup>3</sup>										3.4 m <sup>3</sup>											
High lift arm	General Purpose	Cutting edge	3.6	4.1 m <sup>3</sup>										3.4 m <sup>3</sup>											
		Cutting edge	3.8	4.4 m <sup>3</sup>										3.6 m <sup>3</sup>											
		1-Bolt on tooth	3.4	3.9 m <sup>3</sup>										3.2 m <sup>3</sup>											
		1-Bolt on tooth	3.6	4.1 m <sup>3</sup>										3.4 m <sup>3</sup>											
		2-Bolt on tooth	3.4	3.9 m <sup>3</sup>										3.2 m <sup>3</sup>											
		2-Bolt on tooth	3.6	4.1 m <sup>3</sup>										3.4 m <sup>3</sup>											



# SPECIFICATIONS

CABIN & INTERIOR	STD	OPT
<b>Alternator, 95 A</b>	●	
<b>Alarms, audible and visual</b>		
Air filter clogging	●	
Transmission error	●	
Battery voltage	●	
Brake oil pressure	●	
Engine oil pressure	●	
Parking brake	●	
Fuel level	●	
Hydraulic oil temperature	●	
Engine coolant temperature	●	
Transmission oil temperature	●	
Service brake oil pressure	●	
Engine coolant level	●	
<b>Alarm, back-up</b>	●	
<b>Batteries, PT</b>		
1315 CCA, 12 V, 2 pieces	●	
<b>Gauges</b>		
Engine coolant temperature	●	
Fuel level	●	
Speedometer	●	
Transmission oil temperature	●	
<b>Horn, electric</b>	●	
<b>Indicator lights</b>		
Torque converter lock up	●	
High beam	●	
Turn signal	●	
FNR joystick steering		●
Pilot cut off	●	
<b>LCD Display</b>		
Clock and fault code	●	
Operating hour counter	●	
Engine rpm	●	
Transmission gear range	●	
Indicator	●	
Job time and distance	●	
Temperature (coolant, hydraulic oil, t/m oil)	●	
<b>Lighting system</b>		
LED dome light	●	
2 stop and tail lights	●	
4 turn signals	●	
Brake lights (counterweight)	●	
2 head lights on front tower	●	
2 working lights on front roof		●
4 working lights on front roof, 2 working lights on rear roof		●
4 working lights (2 xenon) on front roof, 2 working lights on rear roof		●
4 working lights (LED) on front roof, 2 working lights (LED) on rear roof		●
2 working lights on grill	●	
2 working lights (LED) on grill		●
<b>Switches</b>		
Hazard	●	
Selective catalytic reduction	●	
Engine hood open	●	
Parking	●	
Battery master switch	●	
FNR shifter	●	
Differential Lock	●	
Secondary steering	●	
Pilot cut off	●	
<b>Ignition</b>		
Key		●
Button	●	
<b>Membrane Switches in monitor</b>		
Main light	●	
Work light	●	
Auto grease		●
Quick coupler		●
Ride control	●	
Work load	●	
Beacon lamp		●
Rear wiper	●	
Mirror heat	●	
Auto position	●	
Fine modulation	●	

CABIN & INTERIOR	STD	OPT
<b>Cab (sound suppressed)</b>		
Cigar lighter & ashtray	●	
Coat hook	●	
<b>Automatic climate control</b>		
Air conditioner & heater	●	
Defroster	●	
Intermittent wiper and washer, front and rear	●	
<b>Seat</b>		
2" retractable seat belt & adjustable mechanical suspension (heated)	●	
2" retractable seat belt & adjustable air suspension (heated)		●
3" retractable seat belt & adjustable air suspension (heated)		●
<b>Personal storage space</b>		
Console box	●	
Holder, can and cup	●	
<b>Rear view mirrors (1 inside)</b>	●	
<b>Rear view mirrors (2 outside)</b>	●	
<b>Rear view mirrors (2 outside, Heated)</b>	●	
<b>Steering column, tilt and telescopic</b>	●	
<b>Steering wheel with knob</b>	●	
<b>Roller type sunshade (front window)</b>	●	
<b>Roller type sunshade (rear window)</b>		●
<b>Tinted safety glass</b>	●	
<b>One door cab</b>	●	
<b>Magazine pocket</b>	●	
<b>Pedals</b>		
One accelerator pedal	●	
One brake pedal	●	
Dual-Brake pedal		●
<b>Accel pedal with ECO switch</b>	●	
<b>Accel pedal without ECO switch</b>		●
<b>Radio/USB player</b>	●	
<b>Rubber floor mat</b>	●	
<b>Wrist rest</b>	●	
<b>24-volt to 12-volt DC converter (20A)</b>		●
<b>ENGINE</b>		
<b>Antifreeze</b>	●	
<b>Engine, CUMMINS, QSL9</b>		
Tier 4 Final / Stage IV	●	
<b>Engine enclosure, lockable</b>	●	
<b>Fan guard</b>	●	
<b>Fuel/water separator (return)</b>	●	
<b>Clean emission module</b>		
DOC and SCR	●	
<b>Rain cap, engine air intake</b>	●	
<b>Radiator</b>	●	
<b>Fuel warmer</b>	●	
<b>Coolant level sight gauge</b>	●	
<b>Engine oil level dipstick gauge</b>	●	
<b>3 Stage Air Precleaner</b>		●
<b>POWER TRAIN</b>		
<b>Service brake (enclosed wet-disk)</b>	●	
<b>Parking brake</b>	●	
<b>Torque converter</b>	●	
Transmission F4 / R3, computer controlled, electronic soft shift, auto-shift and kick-down features included		●
Transmission F5 / R3 with lock-up clutch	●	
Transmission oil sight level	●	
Limited slip differential (front, rear)		●
Transmission oil cooler		●
Transmission oil cooler with thermostat	●	
Hydraulic lock differential (front)	●	
<b>Axle cooling system</b>		●
<b>Tires</b>		
23.5 R25, L3	●	
23.5 R25, XHA2		●
23.5-25, 20PR, L3		●
23.5-25, 20PR, L5		●
<b>Travel speed limiter (20-40 km/h)</b>		●

HYDRAULIC SYSTEM	STD	OPT
<b>Boom kickout, automatic</b>	●	
<b>Bucket positioner, automatic</b>	●	
<b>Diagnostic pressure taps</b>	●	
<b>Hydraulic oil cooler</b>	●	
<b>Hydraulic control, 2 spool</b>		●
<b>Hydraulic control, 3 spool</b>	●	
<b>EH control (Joystick)</b>	●	
<b>EH control (Fingertip)</b>		●
<b>Hydraulic control (Joystick)</b>		●
<b>Hydraulic control (Fingertip)</b>		●
<b>Lever control-single axle (EH control)</b>		●
<b>Joystick Steering</b>		●
<b>Ride control system</b>		●
<b>Secondary steering system</b>	●	
<b>Extra piping-for auxiliary function</b>		●
<b>Quick coupler piping</b>		●
<b>Auto grease system</b>		●
<b>OTHER</b>		
<b>Articulation locking bar</b>	●	
<b>Counterweight</b>	●	
<b>Optional counter weight</b>		●
<b>Door and cab locks, one key</b>	●	
<b>Doors, service access (locking)</b>	●	
<b>Drawbar with pin</b>	●	
<b>Ergonomically located and slip resistant, left &amp; right</b>	●	
Handrails	●	
Ladders	●	
Platforms	●	
Steps	●	
<b>Fenders (front / rear)</b>	●	
<b>Hydraulic oil level sight gauge</b>	●	
<b>Lift and tie-down hooks</b>	●	
<b>Loader linkage, sealed</b>	●	
<b>Z-bar design</b>	●	
<b>Vandalism protection caplocks</b>	●	
<b>Tool kit</b>		●
<b>Tooth, 1 piece, bolt-on type</b>		●
<b>Tooth, 2 pieces, bolt-on type</b>		●
<b>Cutting edge, bolt-on type</b>	●	
<b>Quick coupler</b>		●
<b>Guards</b>		
Crankcase	●	
Transmission	●	
Mud guards	●	
<b>Wheel chock</b>	●	
<b>License plate &amp; lamp (LED)</b>	●	
<b>Hi MATE (Remote Management System)</b>	●	
<b>Rearview camera</b>	●	
<b>SAFETY</b>		
<b>Beacon light, rotating</b>		●
<b>LED beacon light</b>		●
<b>Fire extinguisher</b>		●
<b>Operator suit</b>		●
<b>Boom safety lock</b>		●
<b>LED rear combi lamp</b>		●
<b>LED head light</b>		●

STD = Standard  
OPT = Optional

- \* Standard and optional equipment may vary. Contact your Hyundai dealer for more information.
- The machine may vary according to International standards.
- \* The photos may include attachments and optional equipment that are not available in your area.
- \* Materials and specifications are subject to change without advance notice.
- \* All imperial measurements rounded off to the nearest pound or inch.
- \* The air conditioning system on this machine contains the fluorinated greenhouse gas refrigerant HFC-134a (Global Warming Potential = 1430). The system contains 0.75 kg of refrigerant which has a CO<sub>2</sub> equivalent of 1.0725 metric tonne.



PLEASE CONTACT

**Hyundai Construction Equipment Europe nv**

Hyundailaan 4, 3980 Tessenderlo, Belgium **Tel:** (32) 14-56-2200 **Fax:** (32) 14-59-3405

[www.hyundai.eu](http://www.hyundai.eu)

EN - 2017.11 Rev 3

---